

KOAMTAC

SLED-MSRIC Quick Guide



Contents

1. Product Introduction	2
1.1 SLED-MSRIC Diagram	2
1.2 How to turn on and off	2
2. Assembly Manual.....	3
2.1 How to Assemble into KDC470.....	3
2.2 How to Assemble into SKXPro/5	5
3. Operation.....	7
3.1 Micro USB Port.....	7
3.2 LED Indicator.....	7
4. Useful Special Barcodes.....	8
4.1 MSR (Magnetic Stripe Reader).....	8
4.2 ICCR (IC Card Reader).....	9
4.3 MSRIC Firmware Upgrade Port (Only for SKX-SLED-MSRIC).....	9
5. Usage.....	10
5.1 Using other Developed Applications with free SDK – Android/iOS.....	10
6. Product Specifications.....	11

1. Product Introduction

The SLED-MSRIC is a companion module for the KDC470 and the SKXPro/5. It provides features like a magnetic card reader (MSR) and IC card reader (ICCR).

1.1 SLED-MSRIC Diagram

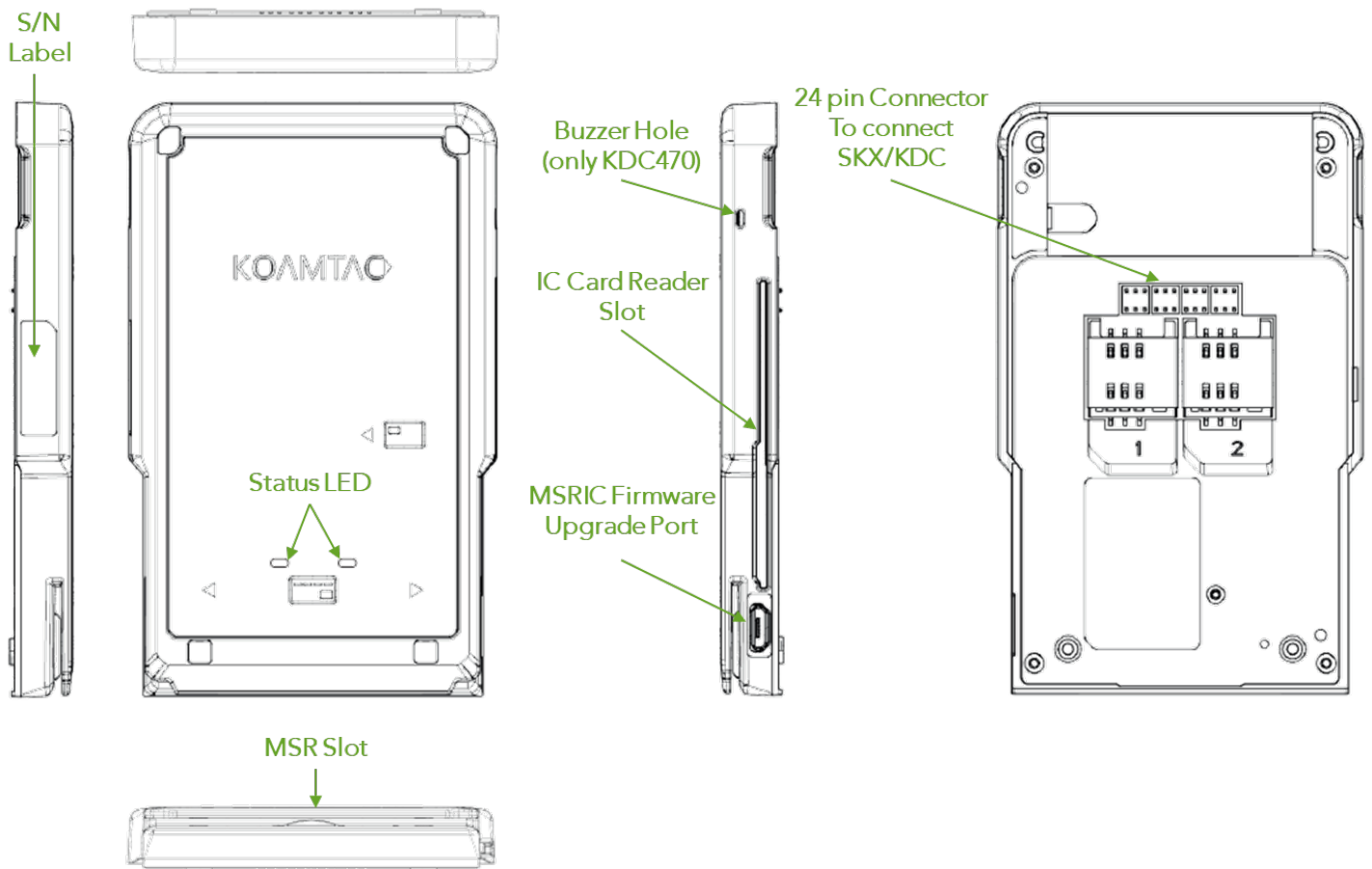

1.2 How to turn on and off

The SLED-MSRIC does not have its own power system. The power is supplied by the KDC470 or the SKXPro/5 (via the XCover Pro/5 Phone).

1. To power on or off a KDC470, simultaneously press the SCAN and DOWN buttons for 3 seconds. The KDC will beep when turned ON or OFF. The KDC will sound a long beep when it is ready to use.

- Regarding the SKXPro/5, you must first power on the phone. To power on the XCover Pro/5, press and hold the SIDE key for a few seconds. To power off the XCover Pro/5, press and hold the VOLUME DOWN and SIDE key simultaneously or alternatively, open the notification panel and tap the power icon.

To locate the SCAN button, DOWN button, or other keys on the phone, reference the product diagram found in the Quick Guide for the KDC470 or SKXPro/5.

2. Assembly Manual

The SLED-MSRIC can be assembled and attached to KDC470 or SKXPro/5. For more detailed information, please refer to the SLED-MSRIC assembly manual. (The images shown below display the SLED-mPOS companion for demonstration purposes).

2.1 How to Assemble into KDC470

What's in the Box?

One (1) of the following devices:

- KDC470 SLED-mPOS Companion
- KDC470 SLED-MSRIC Companion

And:

- 4 screw caps
- 4 screws + 1 extra



KDC470 SLED-mPOS Companion



KDC470 SLED-MSRIC Companion



*KDC470 sold separately. Tweezers and PH0 screw driver (not included) will be necessary to complete assembly.

Assembly Instructions

- Using tweezers, carefully remove all four (4) screw caps from the back of the KDC470. (A)



- Remove all four (4) screws from the back of the KDC470. (B)

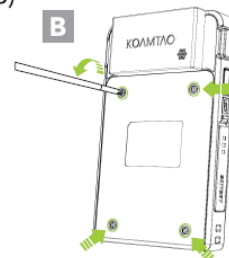

3. Remove the cover plate from the back of the KDC470. (C)

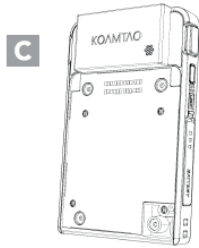

4. Using tweezers, carefully remove the top two (2) screw caps from the back of the KDC470. (D)

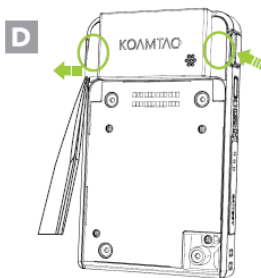

5. Align the screw holes of the SLED-mPOS or SLED-MSRIC Companion with the screw holes of the KDC470. (E)

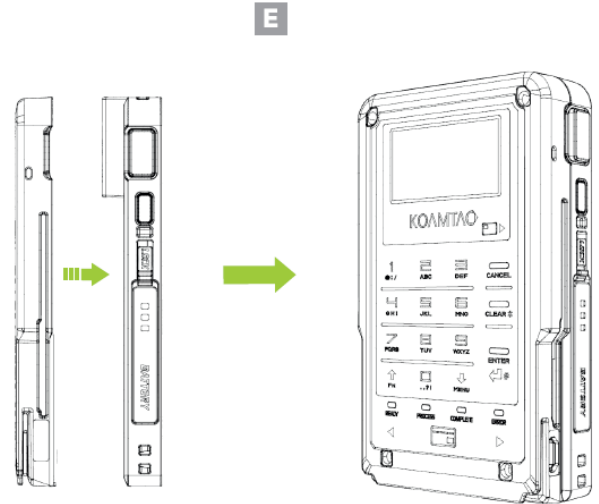

6. Use the four (4) included screws to attach the SLED-mPOS or SLED-MSRIC to the KDC470. (F)

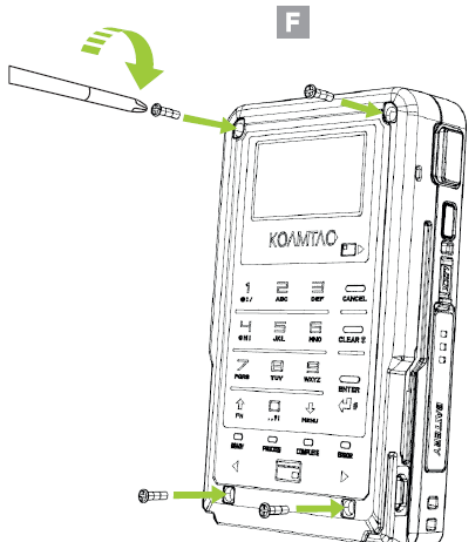

7. Attach the four (4) included screw caps to the KDC470 SLED-mPOS or SLED-MSRIC Companion. (G)

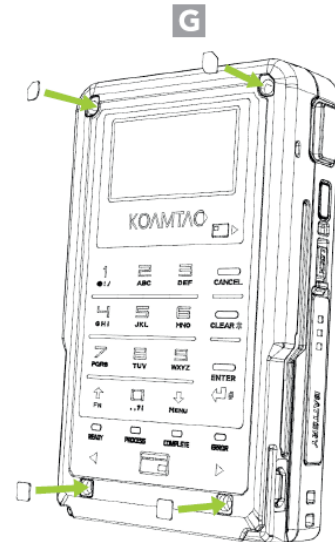

20210618

2.2 How to Assemble into SKXPro/5

What's in the Box?

One (1) of the following devices:

- SKXPro/SKX5 SLED-mPOS Companion
- SKXPro/SKX5 SLED-MSRIC Companion

And:

- 1 contact PCB
- 4 screw caps
- 4 screws + 1 extra



SKXPro/SKX5
SLED-mPOS



SKXPro/SKX5
SLED-MSRIC



*SKXPro/SKX5 sold separately. Tweezers and PH0 screw driver (not included) will be necessary to complete assembly.

2. Separate the companion cover from the SKXPro/SKX5 by removing the terminal protective tape with tweezers. (B)

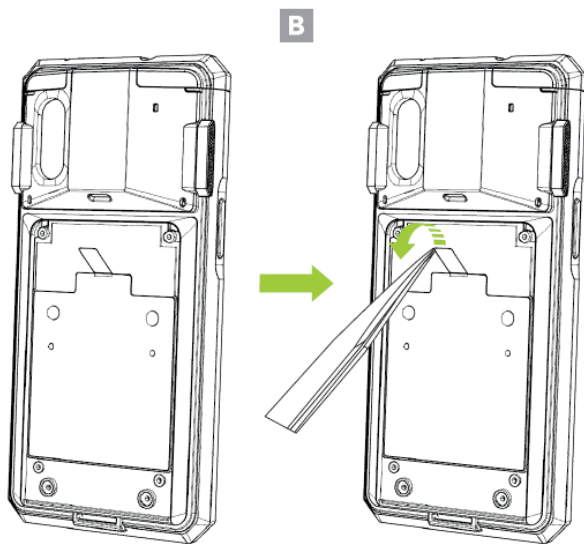

1. Using tweezers, carefully remove all four (4) screw caps from the back of the SKXPro/SKX5. Then, remove all (4) screws from the back of the SKXPro/SKX5. (A)

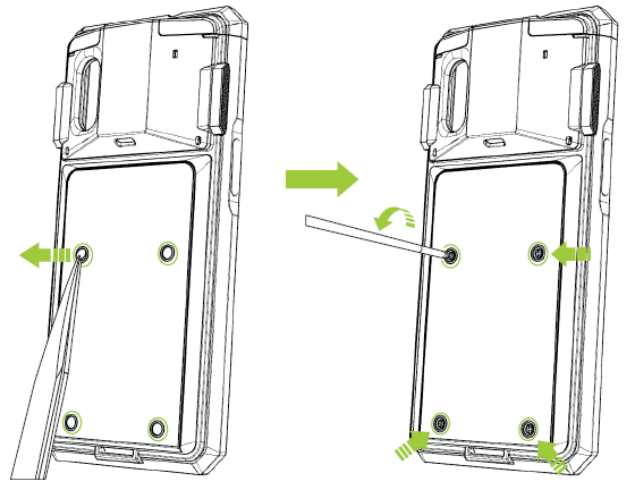

3. Attach the contact PCB to the SKXPro/SKX5. (C)

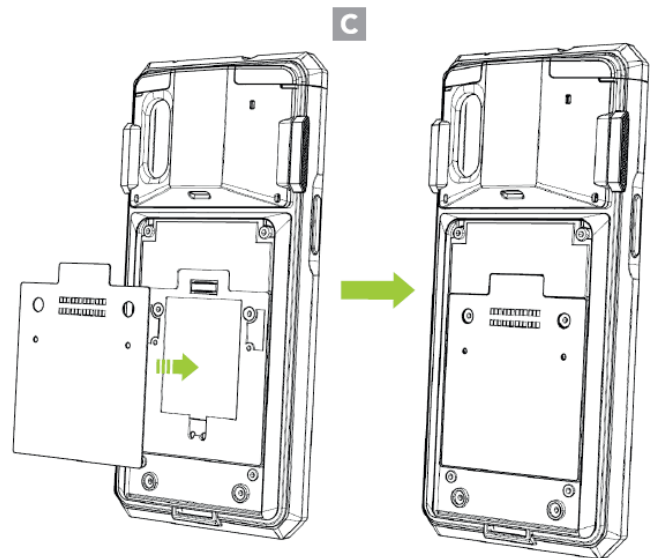

4. Align the screw holes of the SLED-mPOS or SLED-MSRIC Companion with the screw holes of the SKXPro/SKX5. Use the four (4) included screws to attach the SLED-mPOS or SLED-MSRIC Companion to the SKXPro/SKX5. (D)

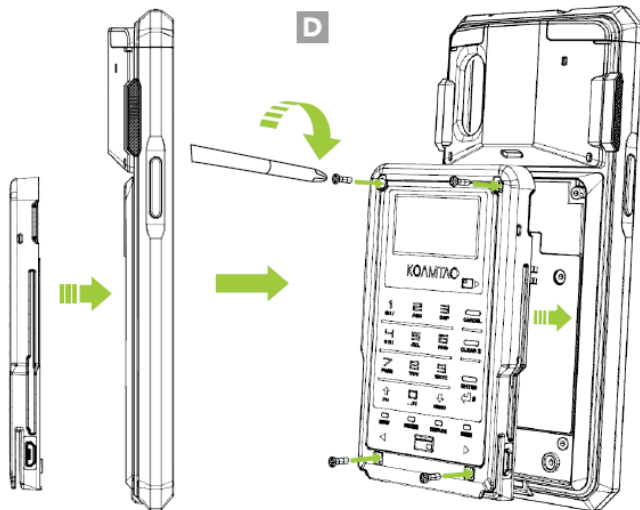

5. Attach the four (4) included screw caps to the SKXPro/SKX5 SLED-mPOS or SLED-MSRIC Companion. (E)

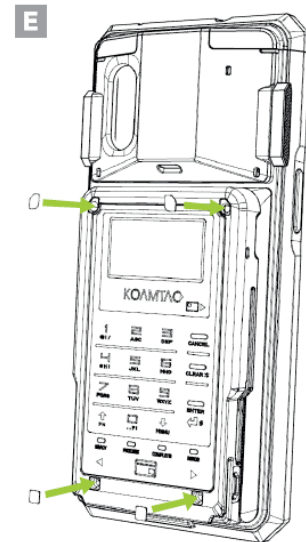

20210616

3. Operation

3.1 Micro USB Port

The SLED-MSRIC has its own USB port on the side.

For KDC470 (KDCSLED-MSRIC), the port is used to upgrade the MSRIC firmware.

For SKXPro/5 (SKXSLED-MSRKC), the port is used to upgrade the MSRIC firmware and used for the data communication with SKXPro/5 and with XCover Pro/5 phone.

3.2 LED Indicator

The SLED-MSRIC has one set of LEDs (two LEDs) on the front.

If the IC Card is inserted and read successfully, the LED turns green. If the reading is failed, it turns red.











If the magnetic card is swiped and read successfully, the LED stays lights green for 0.3 seconds and if not, it says in red for 0.3 seconds.

For KDC470 (KDCSLED-MSRIC), the port is used to upgrade the MSRIC firmware.

4. Useful Special Barcodes

There are several useful special barcodes to configure the SLED-MSRIC.

4.1 MSR (Magnetic Stripe Reader)

<p>Enable MSR Power</p>  <p>┆MKDCMB001.</p>	<p>Disable MSR Power</p>  <p>┆MKDCMB010.</p>
<p>Enable Use Track1</p>  <p>┆MKDCM3001.</p>	<p>Disable Use Track1</p>  <p>┆MKDCM4001.</p>
<p>Enable Use Track2</p>  <p>┆MKDCM3002.</p>	<p>Disable Use Track2</p>  <p>┆MKDCM4002.</p>
<p>Enable Use Track3</p>  <p>┆MKDCM3004.</p>	<p>Disable Use Track3</p>  <p>┆MKDCM4004.</p>
<p>MSR Card Type = ISO</p>  <p>┆MKDCMA000.</p>	<p>MSR Card Type = Other 1</p>  <p>┆MKDCMA001.</p>

<p>MSR Card Type = AAMVA</p>  <p>┆MKDCMA002.</p>	<p>MSR Card Type = JIS 2</p>  <p>┆MKDCMA003.</p>
---	--

4.2 ICCR (IC Card Reader)

<p>Enable ICCR Power</p>  <p>┆MKDCI0001.</p>	<p>Disable ICCR Power</p>  <p>┆MKDCI0010.</p>
<p>IFD Number</p>  <p>┆MKDCI1000.</p>	<p>Config Number</p>  <p>┆MKDCI1001.</p>

4.3 MSRIC Firmware Upgrade Port (Only for SKX-SLED-MSRIC)

<p>Enable SLED USB MODE (To upgrade MSRIC firmware)</p>  <p>«SYN»MKDC5z001.</p>	<p>Disable SLED USB MODE (To access SKX/Phone))</p>  <p>«SYN»MKDC5z000.</p>
--	---

5. Usage

5.1 Using other Developed Applications with free SDK – Android/iOS

A Software Development Kit (SDK) for Android and iOS is available to all KOAMTAC customers to ensure smooth development of applications that work seamlessly with a KDC scanner. It's easy to request the SDK from the KOAMTAC website:

- a) On any web browser, open www.koamtac.com
- b) Navigate to SUPPORT > Downloads > [SDK](#)
- c) Complete the form and submit it.

After submission, a KOAMTAC representative will reach out regarding next steps for completing the SDK Agreement.

The SDK package will have libraries, documents, a sample application, and its source code.

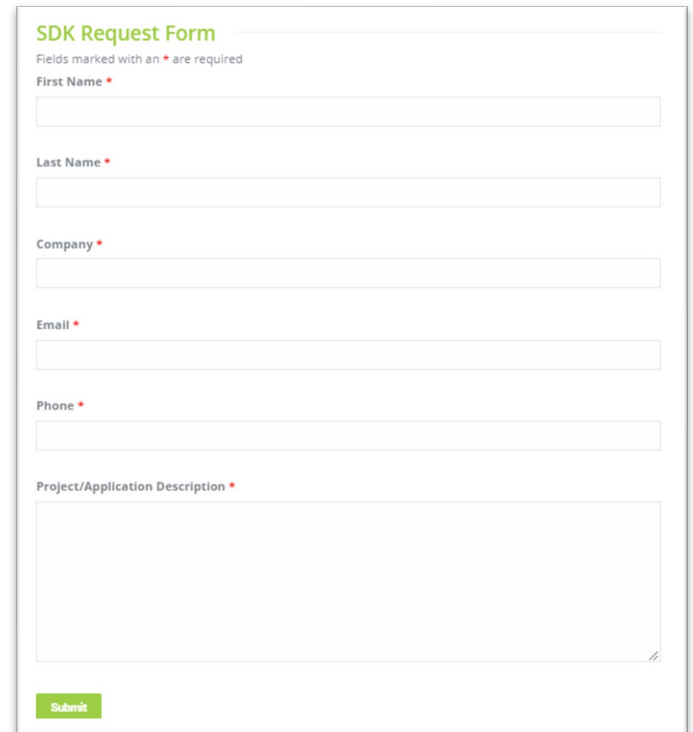

The image shows a screenshot of a web form titled "SDK Request Form". At the top, it says "Fields marked with an * are required". The form contains several input fields: "First Name *", "Last Name *", "Company *", "Email *", and "Phone *", each with a red asterisk indicating it is required. Below these is a larger text area for "Project/Application Description *". At the bottom left of the form is a green "Submit" button.

6. Product Specifications

Physical	Design	KDC470/SKXPro/SKX5 Sled Companion
	Size	2.56" x 4.13" x 0.39" 65 mm x 105 mm x 9.8 mm
	Weight	2.33 oz (66 g)
Functionality	Supporting OS	Android / iOS
	Keys	No
	Buzzer	No
	LED Indicator	2 LED's
	USB Port	Micro USB Port (KDC470: Only for <u>MSRIC Firmware Upgrade Port</u> SKXPro/5: Selective for either <u>MSRIC Firmware Upgrade Port</u> or <u>SKXPro/5 Sled/Phone Access Port</u>)
Memory	RAM	128KB
	ROM	Internal Flash ROM 1MB External Flash ROM 4MB for Encrypted Keys
Environment	Drop Spec	4 ft (1.2 m)
	IP Rating	N/A
	Operating Temp.	-4 °F to 122 °F (-20 °C to 50 °C)
	Storage Temp.	-4 °F to 140 °F (-20 °C to 60 °C)
	Humidity Spec	5% ~ 95% (non-condensing)
Regulatory Conformance	Laser Safety	N/A
	LED Safety	N/A
	Regulatory	CE/FCC/KC/RoHS
	Payment	EMV Level 1 Contact
Standard Supported	MSR Standard & Type	ISO 7810, 7811, 7813, AAMVA, Custom Data Format
	MSR Read Card Format / Handling Method	Track1, Track2, Track3 / Manual swipe, Bidirectional
	IC Card Reader Standard	ISO7816 (T=0, T=1)
	IC Card Reader Card Type	ISO7816 Class A, B, C (5V, 3V, 1.8V) Smart Cards
	IC Card Reader Compliance	EMV Level 1 Contact
	Data Encryption Method	AES128/192/256, DES/TDS, RSA (2048)